

Profilo in alluminio ad alta dissipazione

Profilo

Codice: PL1813

Opzioni Lunghezza

2 m, 3 m, 6 m

Varianti disponibili

Argento, Nero, Bianco

Dimensioni Meccaniche

Larghezza: 18 mm

Altezza: 13 mm

Profilo ad alta dissipazione in alluminio anodizzato argento o verniciato in RAL, ideale per alloggiare al proprio interno strisce LED flessibili. Lo scopo del profilo è quello di dissipare il calore, proteggere e dare un aspetto estetico più gradevole alle strip LED.

MAX
17 W

Dati tecnici

Calpestabile No

Impermeabile No

Da incasso Sì

Tipologia profilo In alluminio

Potenza MAX applicabile: 17 W/m

MONTAGGIO:

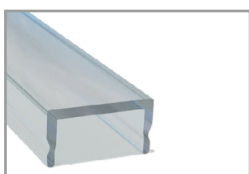
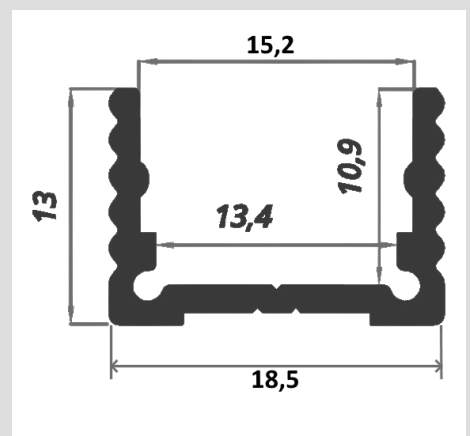

Copertura piana polic.

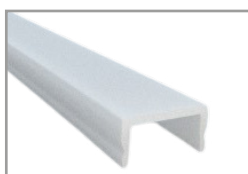

Copertura piana pmma opalino

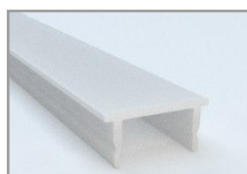

Copertura piana larga

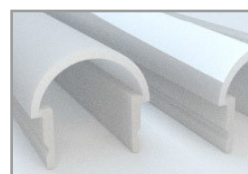

Copertura arrotondata



Copertura lenticolare

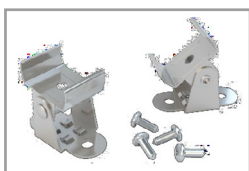

Graffette orientabili INOX

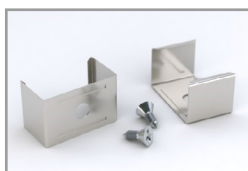

Graffette INOX



Giunzione in acciaio INOX



Graffette angolari INOX

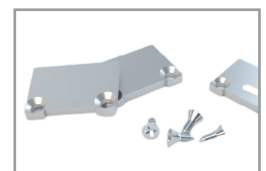

Kit-1 tappi anodizzati

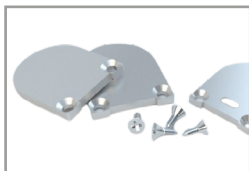

Kit-2 tappi anodizzati



Kit-3 tappi anodizzati



Kit-4 tappi anodizzati

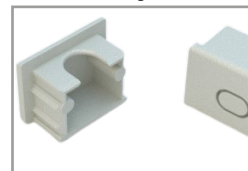

Kit-5 tappi in plastica

MADE IN ITALY

TILSYSTEMS SRL